



POWERCAST®

# RF Wireless Power: An Enabling Technology

Presented to WiPoT  
September 9, 2014



Charles Greene, Ph.D.  
Chief Technical Officer



Emerging  
Technology



Gold Level Winner

P2100  
Powerharvester®



EDN  
2010  
Hot 100

TX91501  
Powercaster®



P2110  
Powerharvester®



P2110  
Powerharvester®

# Agenda

- ❖ **Introduction to Powercast Corporation**
- ❖ **Overview of RF Wireless Power**
- ❖ **Powercast Products**
- ❖ **Performance Data**
- ❖ **Applications of RF Wireless Power**
- ❖ **Specific Examples of Implementations**

# Powercast Overview

## RF Wireless Power company founded in 2003

- Privately held company
- Located in Pittsburgh, PA, USA

## Enabling products that eliminate Batteries & Battery Maintenance

- ❖ Products address existing and future markets
  - RF wireless power harvesting ICs and modules
  - RF wireless power transmitters
- ❖ Full suite of leading-edge, FCC approved products
- ❖ Products sold by numerous distributors (TED)
- ❖ Significant opportunities for OEM integration of wireless technology
- ❖ 16 U.S. patents issued and 10 U.S. patent applications (worldwide filings)



# Introduction to RF Wireless Power



# RF Energy is Everywhere



# RF Power Sources

## Intentional



## Anticipated



## Unknown

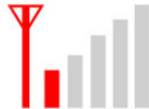

# Power Profiles and Target Devices

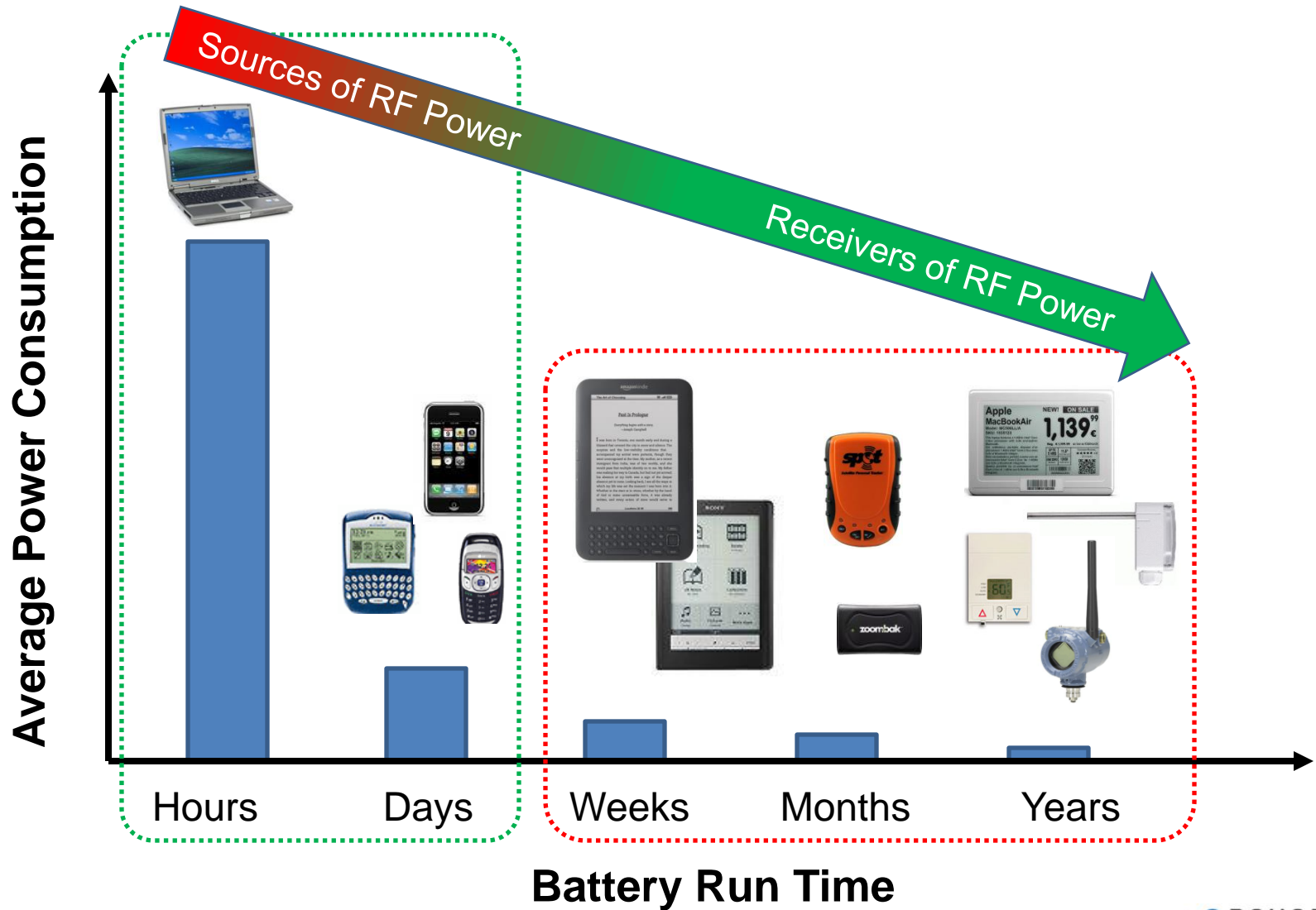

# RF Wireless Power Overview

Intentionally broadcast Radio Frequency (RF) provides wireless power over distance

- Inches to over 100 feet depending on application
- Power from microwatts ( $\mu\text{W}$ ) up to milliwatts (mW)

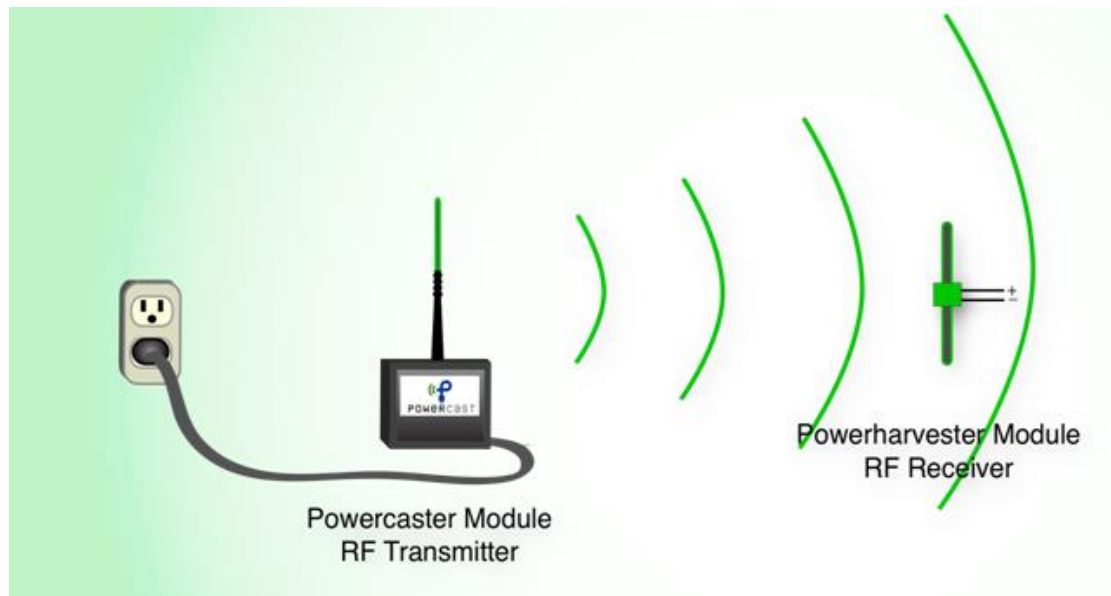

## Controllable by Design

- Power Level
- Frequency
- Transmit Antenna Gain
- Receive Antenna Gain
- Number of Transmitters
- Distance
- Device Duty Cycle
- System Cost

$$P_R = P_T \frac{G_T(\theta_T, \phi_T) G_R(\theta_R, \phi_R) \lambda^2}{(4\pi r)^2} (1 - |\Gamma_T|^2) (1 - |\Gamma_R|^2) |\hat{\mathbf{p}}_T \cdot \hat{\mathbf{p}}_R|^2$$





# Market Segment Value Propositions

## ❖ **Industrial – *Minimizes Operating Costs***

- Eliminates cost to hard wire or replace batteries – e.g. wireless sensors
- Eliminates service downtime caused by depleted batteries
- Reduces battery handling and disposal

## ❖ **OEMs – *Improved Product Design***

- Product differentiation – eliminate wires, cables, connectors
- Sealed devices – less expensive enclosures and manufacturing, waterproof
- Reliability – improved durability, reduced product failures, eliminate ESD

## ❖ **Consumers – *Convenience and Usability***

- Placement flexibility – no charging mats or charging stations
- Untethered embedded power – eliminate wires, cables, connectors
- Transparent charging – no user action required

# Powercast Products



# Full Suite of RF Wireless Power Solutions

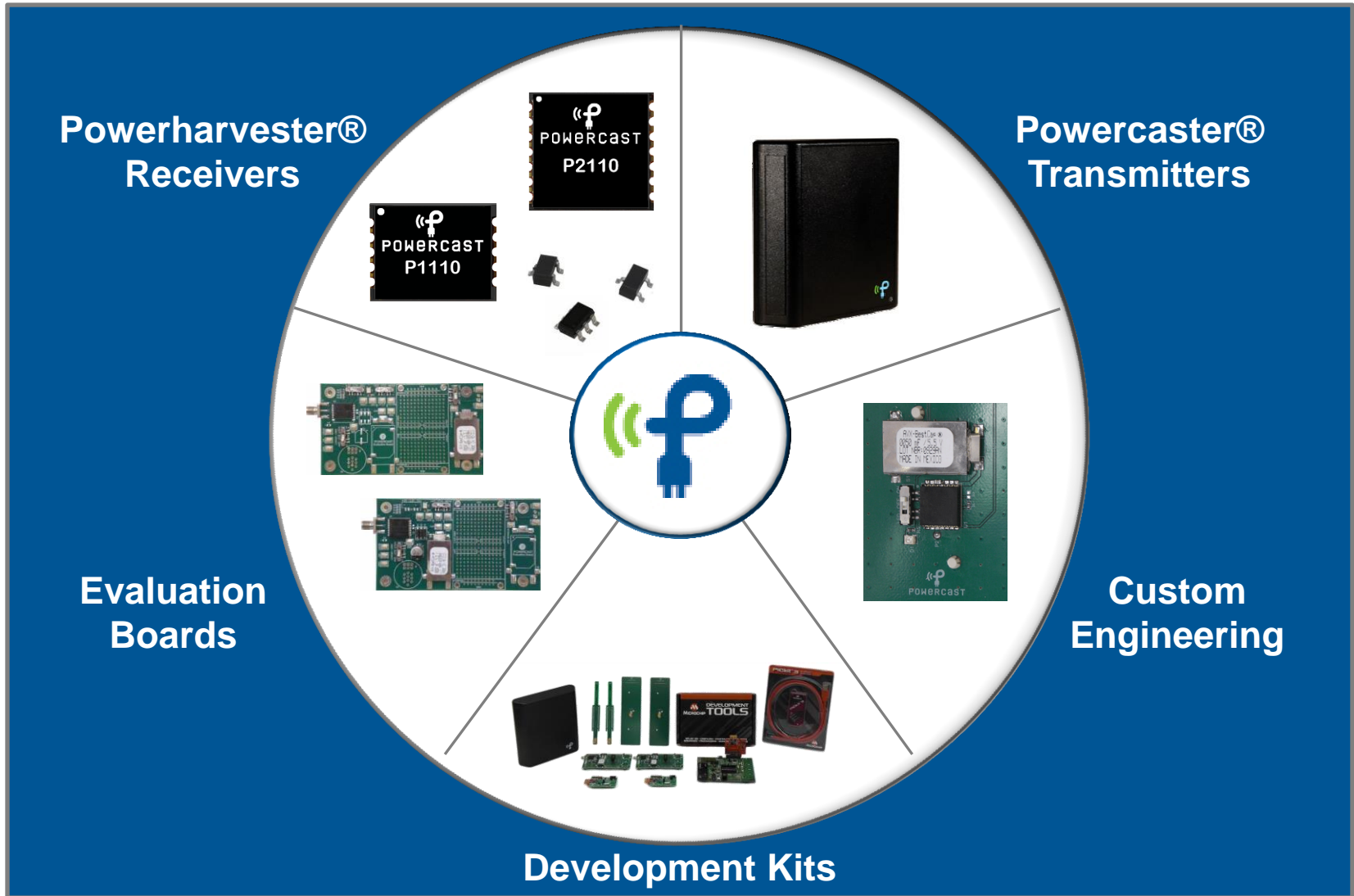

# Powerharvester® Chipset

## PCC110 – RF to DC Converter

- ❖ High conversion efficiency, up to 75%
- ❖ Converts low-level RF signals enabling long range applications
- ❖ RF operating range: -18dBm to +20dBm
- ❖ Frequency range: 10MHz to 6GHz
- ❖ Harvests from all modulation types
- ❖ Interoperable with numerous RF sources: Powercast TX91501 transmitter, RFID readers, Mobile Phones, Wi-Fi routers, etc.
- ❖ SC-70 package



## PCC210 – Boost Converter

- ❖ High efficiency, up to 95%
- ❖ Operation down to 0.4V input
- ❖ Capable of 5.5V @ 50mA output
- ❖ Resistor settable output voltage
- ❖ SOT23-6 package



### Reference Designs Available (Others available on request):

**P1110** 915MHz high-efficiency continuous powering and recharging

**P2110** 915MHz long-range pulsed powering and pulsed recharging

**P2111** P2110 with enhanced sensitivity

**P2120** 2.45GHz long-range pulsed powering and pulsed recharging

# Powerharvester<sup>®</sup> Modules

- Modules allow easy deployment – RF in → DC out
- Provide high RF to DC conversion efficiency
- Power microcontrollers, sensors, electronics
- Designed for standard 50Ω antennas
- Support multiple frequency bands: 840-960MHz
- Based on Powercast PCC110 & PCC210 ICs

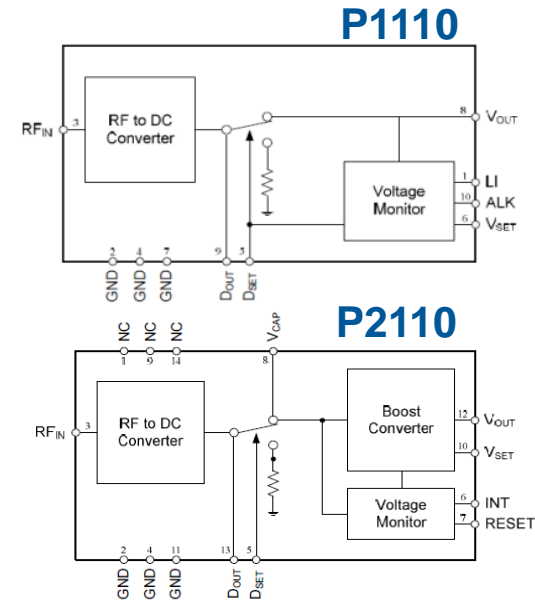

## P1110 Architecture

### Continuous Power Output

- RF range: -5.0dBm to 20dBm
- Output voltage: 1.8V to 4.2V (configurable)
- Range of 3 meters or more



## P2110 Architecture

### Pulsed Power Output

- RF range: -12dBm to 15dBm
- Output voltage: 2V to 5.5V (configurable and regulated)
- Range of 10 meters or more



# TX91501 Powercaster<sup>®</sup> Transmitter

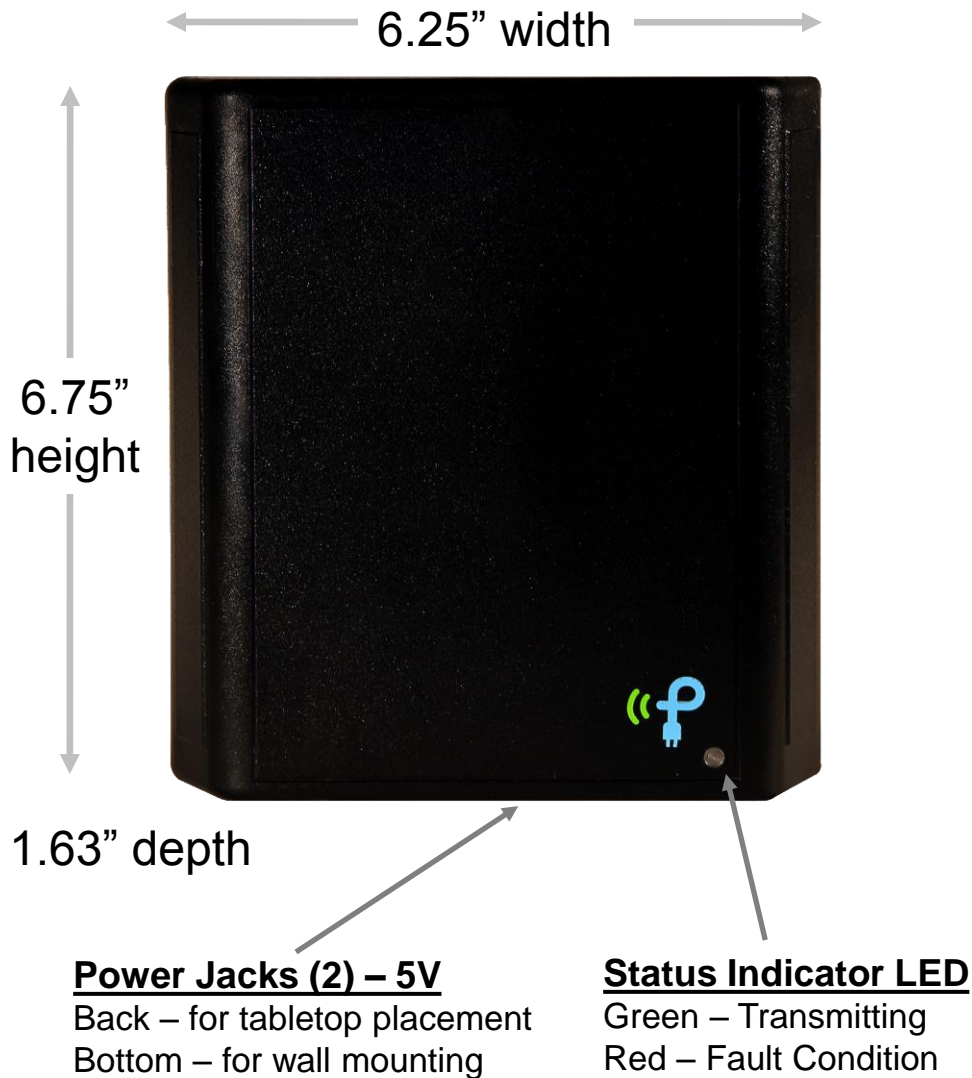

- ❖ 915 MHz center frequency
- ❖ FCC and IC certified
- ❖ RoHS compliant
- ❖ DSSS modulation (power)
- ❖ ASK modulation (data)
- ❖ 1W or 3W EIRP
  - TX91501-1W-ID
  - TX91501-3W-ID
- ❖ Integrated antenna with 60° beam pattern
- ❖ Data broadcast (factory-set)
- ❖ Plug-and-play installation
- ❖ Powers virtually unlimited number of Powerharvesters

# Lifetime Power<sup>®</sup> Development Kit

## P2110-EVAL-01

### ❖ Complete system for battery-free wireless applications

- Jointly developed with Microchip Technology
- Designed for wireless sensing applications using MiWi protocol
  - RF Transmitter (TX91501-3W-ID)
  - Two P2110 Evaluation Boards (P2110-EVB)
  - Two 6dBi Directional Antennas (PA-915-01)
  - Two 2.5dBi Omni-directional Antennas (DA-915-01)
  - Two Wireless Sensor Boards (WSN-EVAL-01) – Temperature, Humidity, Light Level
  - Microchip 16-bit XLP Development Board
  - Microchip MRF24J40 PICtail/PICtail Plus daughter card
  - Microchip PICkit 3 programmer/debugger



# Performance Data





# Powercast Technology Advantages

## ❖ High efficiency over a broad range:

- Load resistance
- Input power
- Recharging current

## ❖ No Maximum Power Point Tracking (MPPT) required

## ❖ Over 850 MHz operating bandwidth

- Essential for ambient energy harvesting
- Easy scalability for geographic regions using different frequencies

## ❖ Result ...

- Better performance
- More power
- Simplified design-in

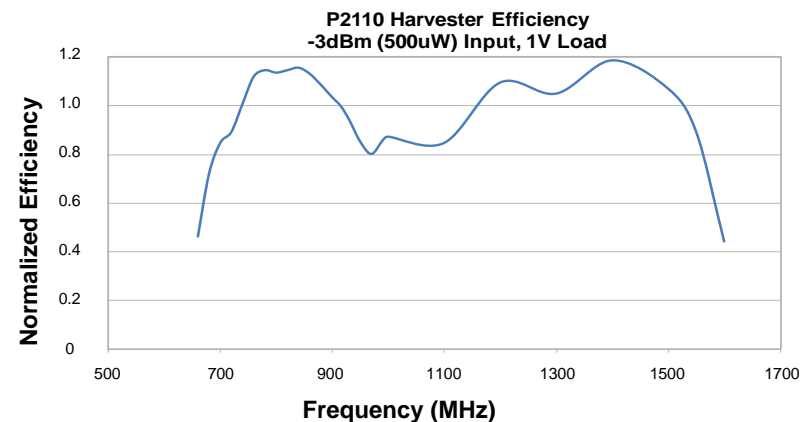
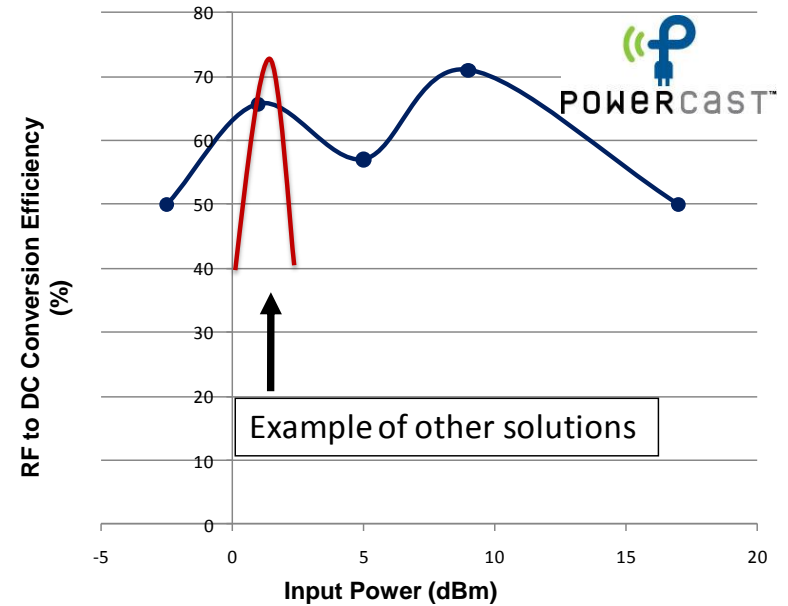

# 915MHz Link Budget Analysis

$$P_R = \frac{P_T G_T G_R \lambda^2}{(4\pi R)^2}$$

Parameter	Gain/Loss	Total
Transmitted Power (From amplifier) - $P_T$	27dBm (0.5W)	
Transmitter Antenna Gain - $G_T$	8.34dBi	
EIRP ( $P_T G_T$ )		<b>35.34dBm</b> <b>3.4W</b>
Path Loss (Distance dependent) - $\lambda^2/(4\pi R)^2$		
1m	-31.68dB	
5m	-45.65dB	
10m	-51.68dB	
<b>12m</b>	<b>-53.25dB</b>	
Receiver Antenna Gain - $G_R$	6dBi	
Received Power - $P_R$		<b>-11.91dBm</b>
RF to DC Converter	-5.2dB (30%)	
Usable Power*		<b>-17.11dBm</b> <b>19.45uW</b>

\*Using the Powercast P2110, this energy is continuously stored in a capacitor and provided to the load intermittently. The energy is stored at approximately 1V and is boosted to a user selectable voltage (2 to 5.5V) at 85% efficiency. The output current can be up to 50mA for a duration set by the capacitor value.

# Available Power at 915MHz

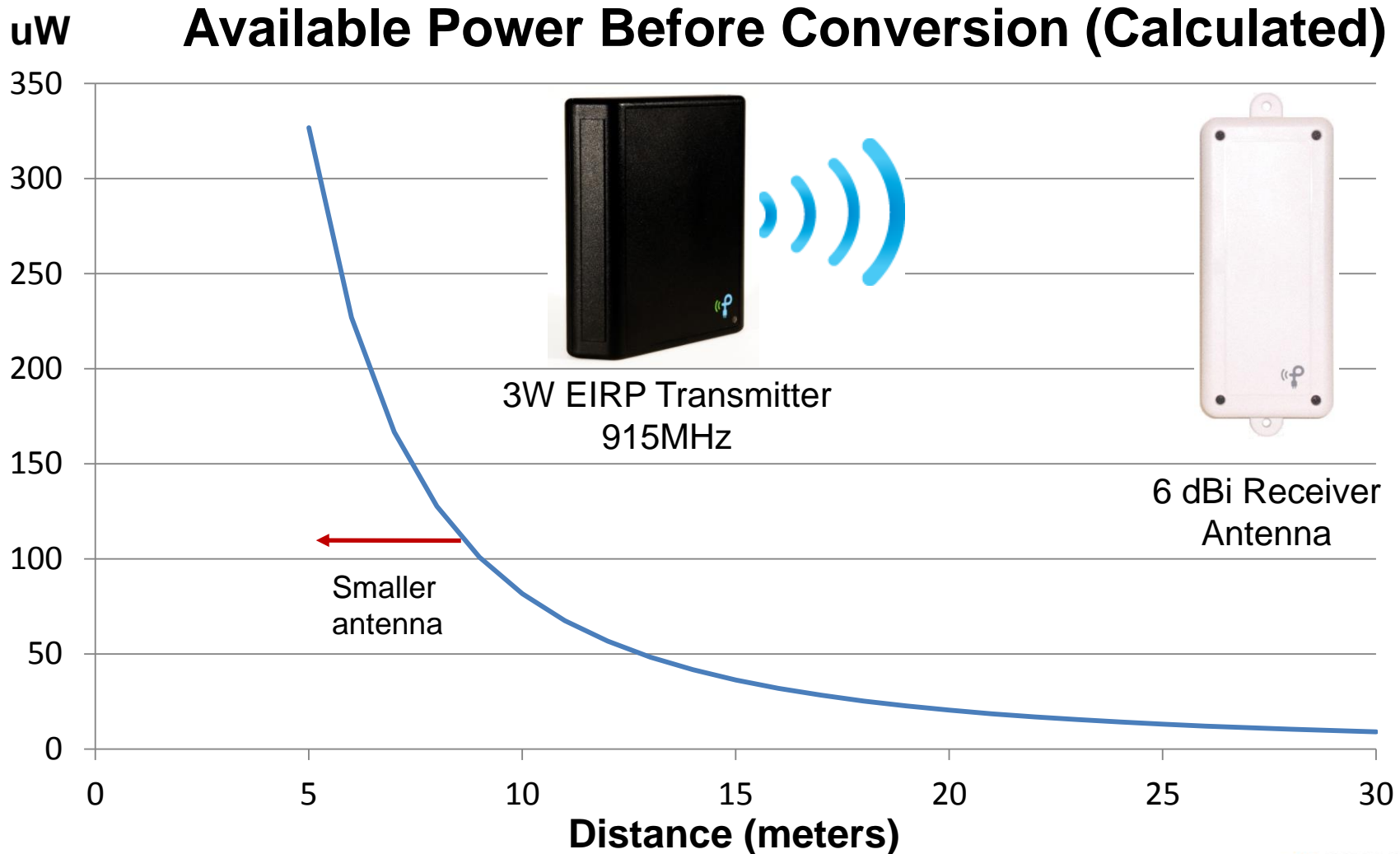

# Powerharvester<sup>®</sup> Performance Comparison

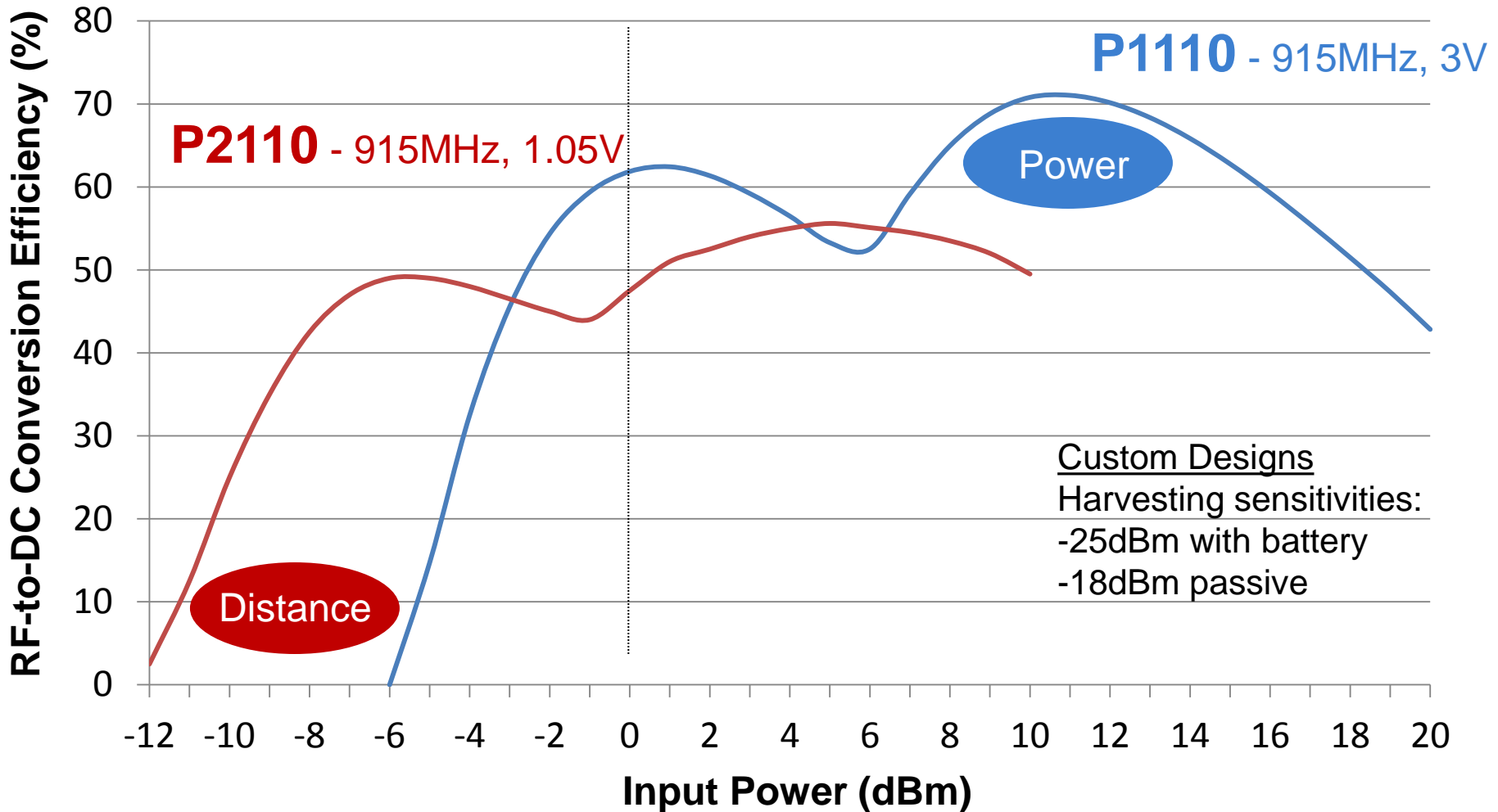

# Harvested Power at 915MHz

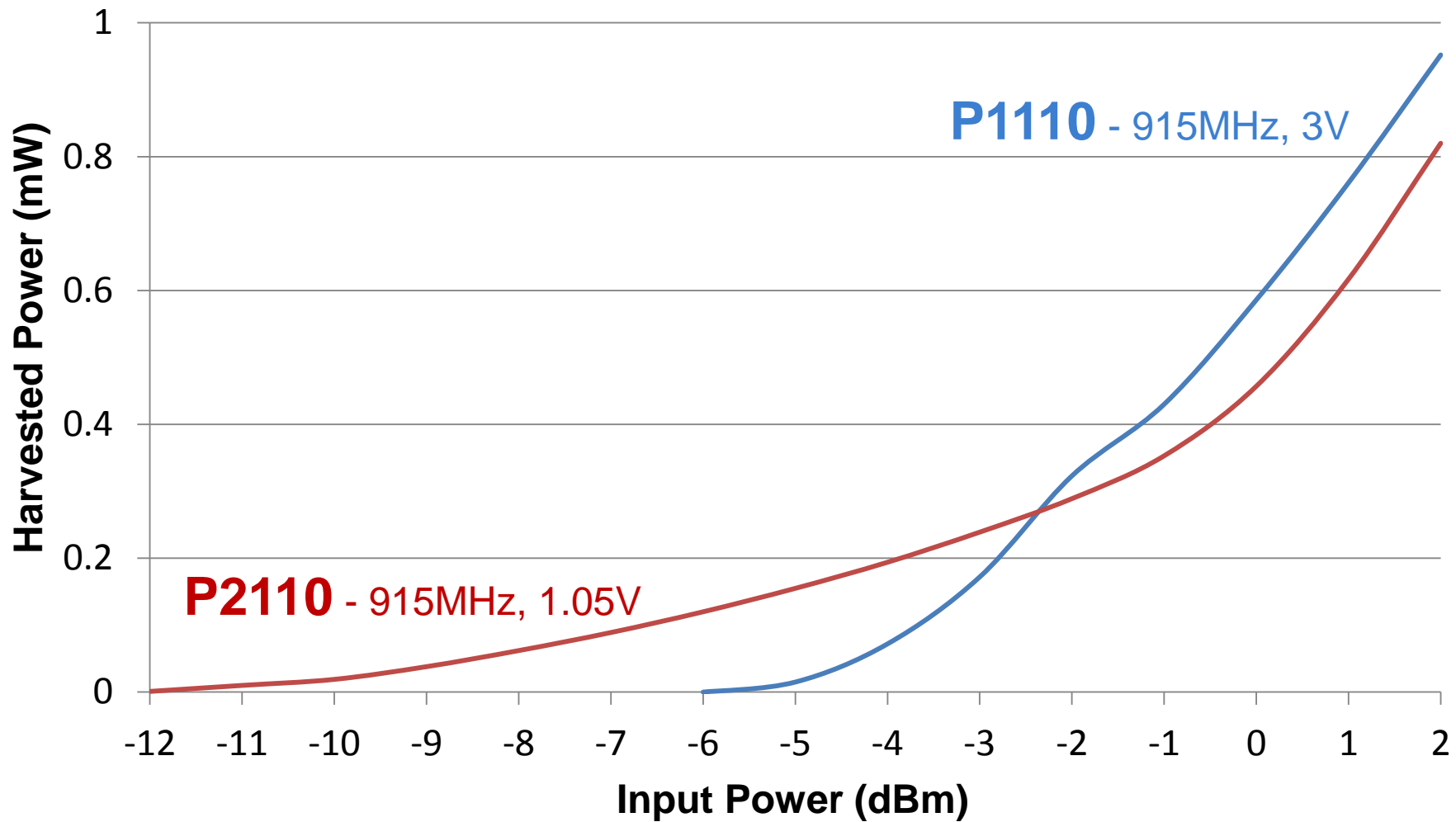

# Applications of RF Wireless Power



# Application: Wireless Power Network for Sensors

- ❖ **Powercast enables a complete wireless infrastructure for micro-power and data**

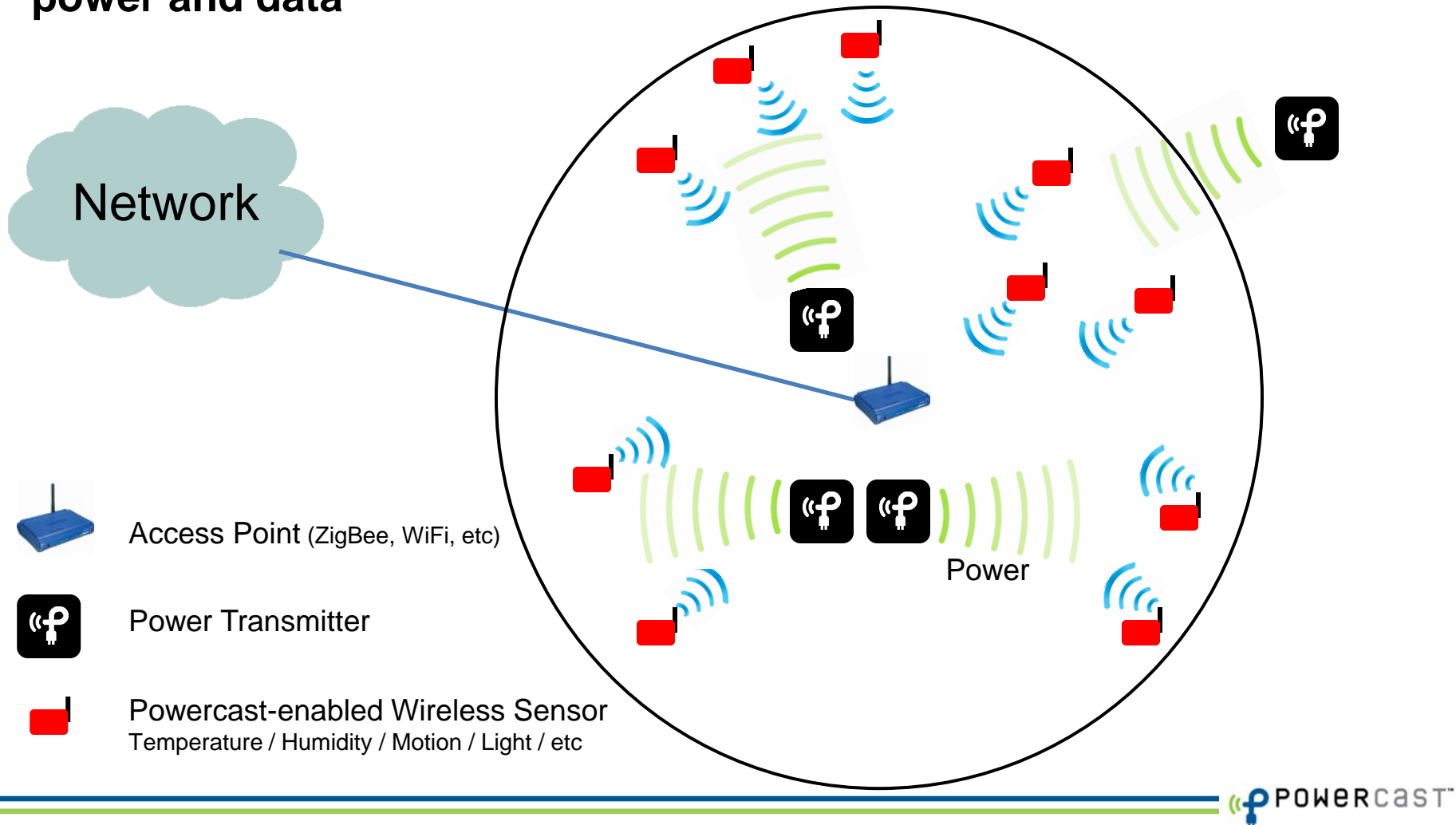

# Application: Bulk Trickle Charging

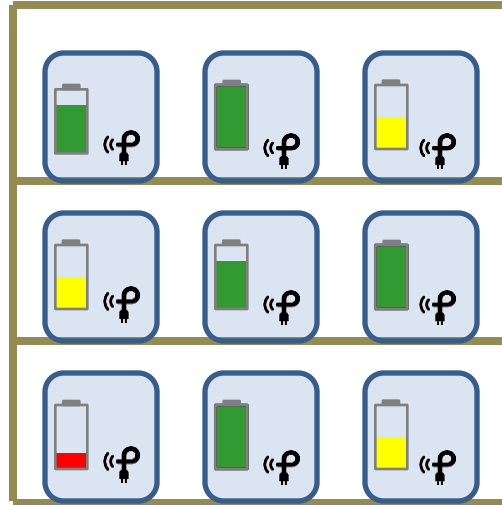

- Freedom of placement
- Eliminate wires and connectors
- Automatic/transparent charging
- Multiple battery types/chemistry





# Application: Desktop Charging Hot Spot

Suitable for low-usage items or longer charge times (+6 hours)



# Application: High-Function RFID Tags

## UHF RFID Reader



Up to 12 meters



- Identification
- Sensing
  - Temperature
  - Vibration
  - Heart Rate
  - Stress/Strain
  - Shock
- Smart Packaging
  - Bi-Stable Display
  - Indications – LED, Audible
- Security
  - Biometrics and Encryption

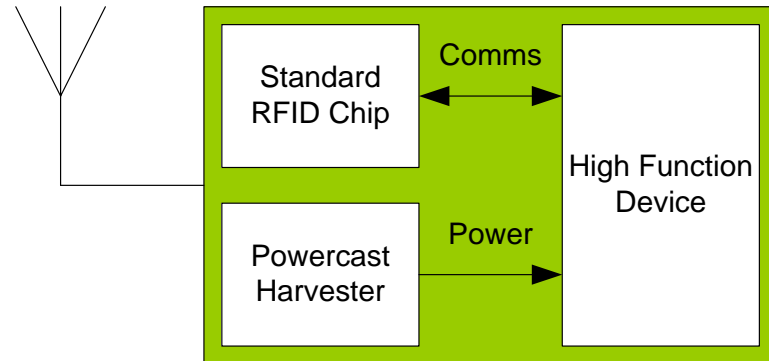

Powercast provides >10X the power vs. traditional RFID

# RFID Tag Power Requirements

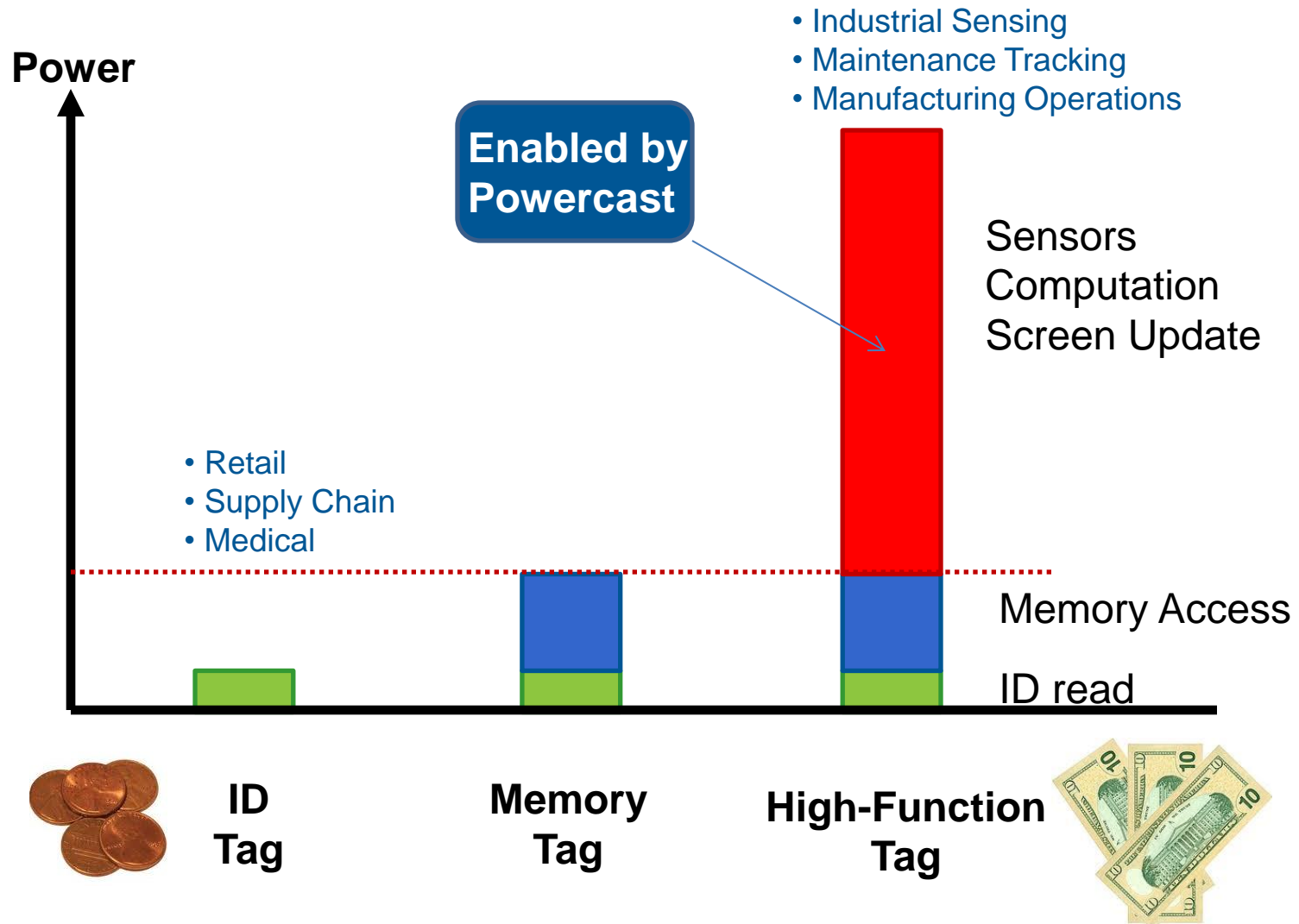

# Demonstrations – EPC C1G2 RFID Tags

## Temperature & Indication

- ❖ Range: 12 meters
- ❖ Read/Write capable
- ❖ Temp Range: -40 to 85C
- ❖  $\pm 1\%$  Accuracy
- ❖ LED Indications
  - Temp update (Green)
  - Find-tag indication (Red)



## Visual Bi-Stable Display

- ❖ Range: 2-4 meters
- ❖ Read/Write capable
- ❖ Image sent from Reader
- ❖ Image retention without power



# RF Wireless Power Markets



**Identification**



**Electronic Labeling**



**Automation Sensors**



**Cold Chain**



**Access Control**



**Industrial Monitoring**

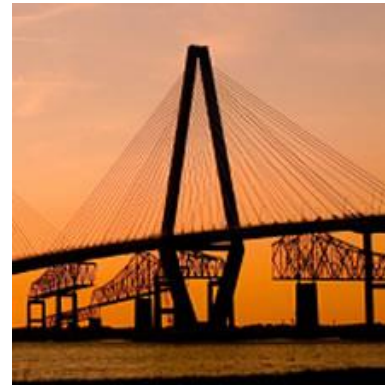

**Structural Monitoring**



**Defense**

# RF-Power Market Growth

❖ As the cost and size of RF-power solutions decrease, opportunities to address additional high-volume markets will increase significantly

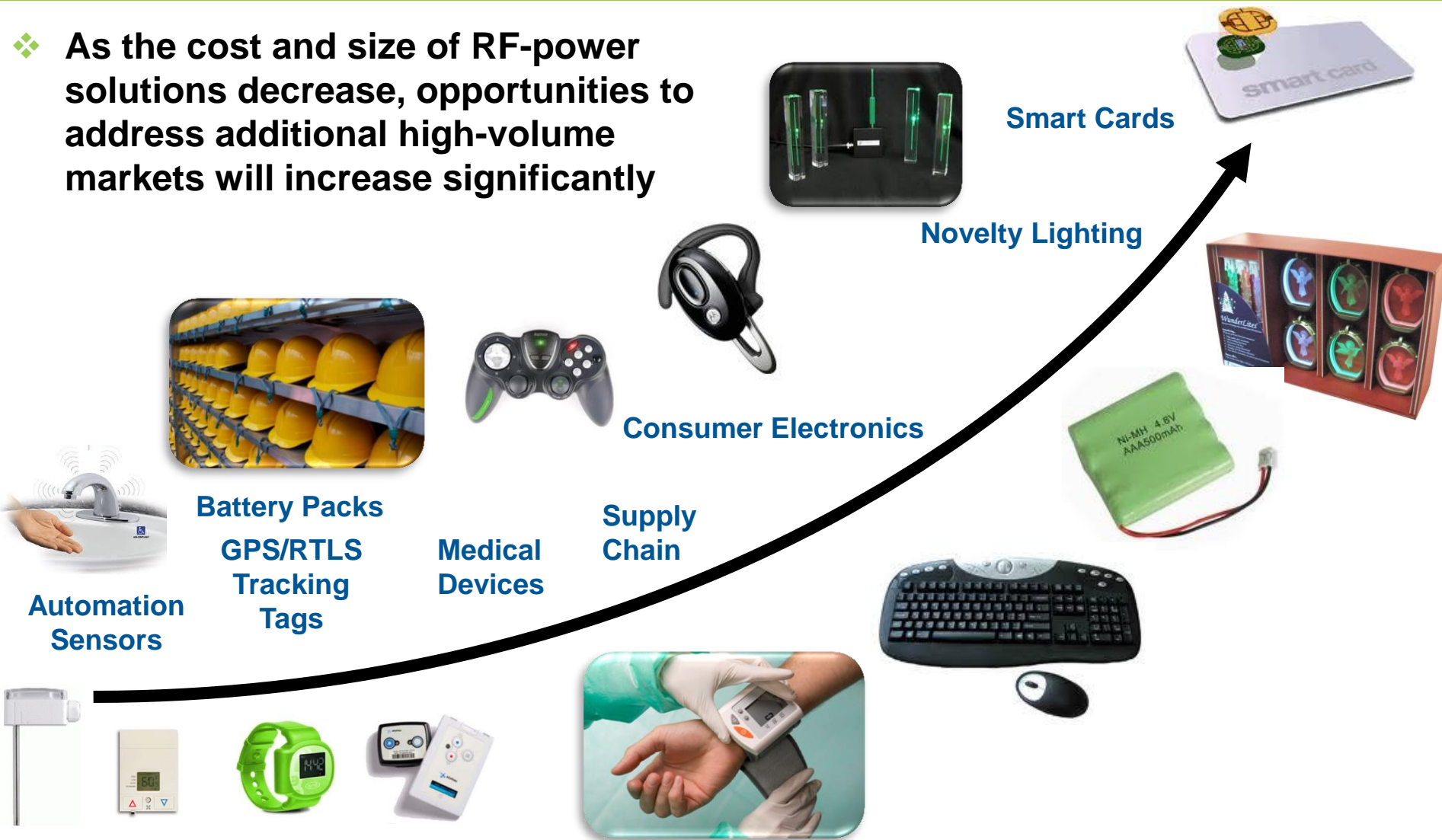

# Specific Examples of Implementations



# Example: Wireless Sensor Battery Recharging

## Pittsburgh Zoo Penguin Exhibit:

Sensitive environment, high value assets, very limited access

## Problem:

Battery replacement every 3-4 months in wireless sensor nodes

## Solution:

Powercast RF wireless power system to provide continuous battery charging and perpetual battery life

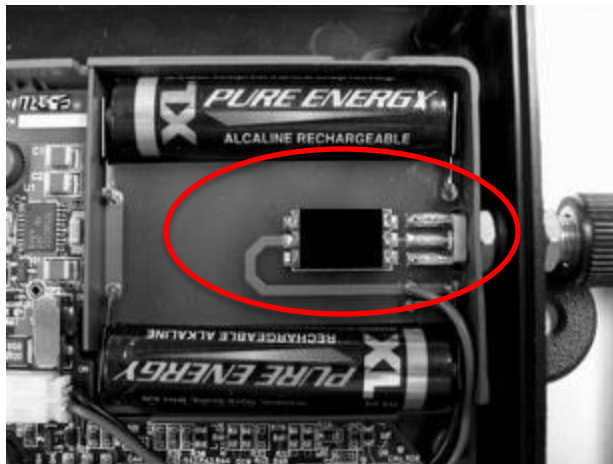

Battery compartment retrofitted with Powercast RF Harvester

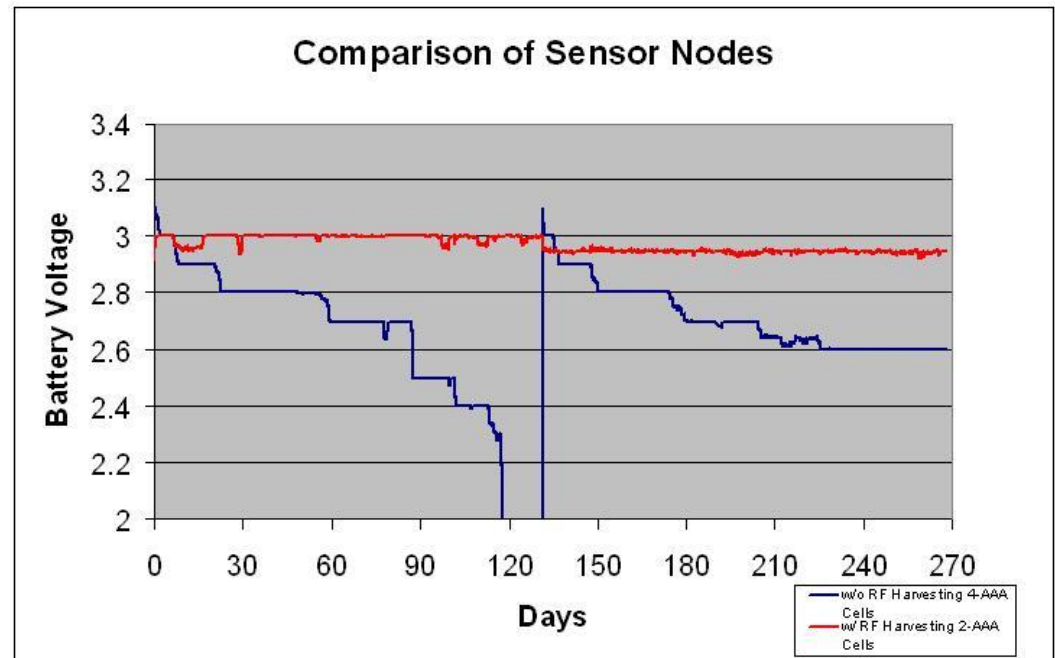



# Example: Passive UHF RFID Sensing

- ❖ Used in shipping and warehouse applications
- ❖ Monitor temperature inside shipments
  - -40 to 85C
- ❖ Monitor shock and tilt of packages or totes
  - $\pm 3$  g
- ❖ Waterproof and flexible packaging
- ❖ Customizable graphics
- ❖ Packaged in Teslin®
  - Durable synthetic paper that offers easy, high-quality printability, strong adhesion, and thermal/chemical durability
  - Acts like miniature bubble wrap, protecting the embedded RFID inlay and other electronics
  - Independent laboratory studies show lasts two to three times longer than PVC cards

## ❖ Passive Temperature



## ❖ Passive Acceleration

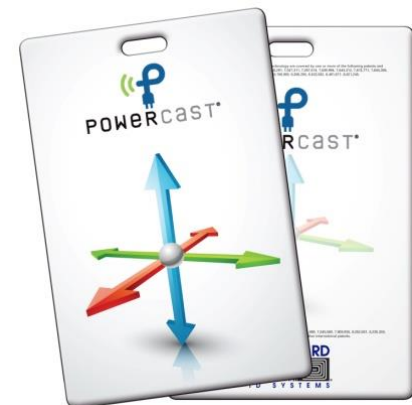

# Example: Decorative Lighting

## ❖ **Wireless Christmas Tree**

- Eliminates interconnecting wires
- Two RF transmitters located inside the tree
- A passive harvester directly drives each LED, 100 per tree
- Numerous lighting effects can be achieved via patented modulation techniques



## ❖ **Decorative lighting technology being included in other products**

- Stickers
- Labels
- Illuminated product packaging



# Example: Industrial Oven Temperature Monitoring

## ❖ Wyze Temp®HT High Temp Battery-less Probe

- Temperature sensing without batteries! (Sensors are powered up by the reader RF energy)
- Numerous temperature probes can be read simultaneously
- Perfect for conveyor ovens and rotisseries where tethered probes cannot be used
- Bakery goods and other foods that go through cooking and cooling zones benefit by real time temperature tracking
- Product benefits include: continuous cooking operation, no interruption of cook process to measure product temperature, long-term product reliability, improved safety for employees



# Powercast Resources

## ❖ Documentation

- <http://www.powercastco.com/documentation/>

## ❖ Wireless power calculator (Excel)

- <http://www.powercastco.com/power-calculator/>

## ❖ Videos and Presentations

- <http://www.youtube.com/powercastco>
- <http://www.slideshare.net/powercast>



Emerging  
Technology



Gold Level Winner  
P2100  
Powerharvester®



TX91501  
Powercaster®



P2110  
Powerharvester®



P2110  
Powerharvester®



566 Alpha Drive  
Pittsburgh, PA 15238 USA  
[www.powercastco.com](http://www.powercastco.com)

# Thank You

Charles Greene, Ph.D.  
Chief Technical Officer  
+1.412.923.4770  
[cgreene@powercastco.com](mailto:cgreene@powercastco.com)